



FuturaSun[®]

anticipate tomorrow

SAFETY AND INSTALLATION MANUAL

Photovoltaic Modules:
FU XXX M / MV / P / PV
FU XXX M / MV NEXT
FU XXX M / MV NEXT PRO

Contents

1. General Information	3
2. Disclaimer of Liability	4
3. IEC 61215 & 61730 certifications	4
4. Limited Warranty	4
5. Module Specification	4
6. Safety Precautions	4
7. Installation	5
8. Use and Maintenance	12
9. Packaging, Handling and Storage of Modules	14

1. General Information

The photovoltaic (PV) modules FU XXX M / MV / P / PV / NEXT / NEXT PRO, (hereafter “FU XXX” or “FU”) are devices that produce electrical energy by converting the sunlight’s radiation reaching their surface, when appropriately exposed, into continuous/direct current (DC).

The FU modules are intended to be used in photovoltaic module systems connected to the electrical grid. It is also possible to use them in battery powered photovoltaic module systems (stand alone).

The rated currents at Standard Test Conditions (STC) of the FU modules are variable depending on the model and the relative power rating, as indicated in the respective **technical data sheets**. Most of the electrical parameters of the modules, specified in the datasheets, are determinable only by using special instrumentation in the laboratory; therefore, only some of them are measurable outside of a lab, using common instrumentation (*voltmeter, AM meter, solarimeter/pyranometer*).

It is possible, following very precise procedures, to carry out electrical measurements of voltage and current as snapshots, which enable you to monitor the operation of the modules and determine possible, although rare, anomalies.

The electrical output parameters for FU modules, of technical importance during the operation, installation and maintenance, are the following:

- Voltage at open circuit (V_{oc}) with tolerance of $\pm 4\%$
- Current at short circuit (I_{sc}) with tolerance of $\pm 5\%$
- Voltage at point of maximum power (V_{mpp})
- Current at point of maximum power (I_{mpp})
- Power (P_{max}) with tolerance of $\pm 3\%$
- Solar radiation in W/m^2 at the time
- Temperature of the modules

The general performance of the modules is heavily dependent on the intensity of the

incident solar radiation, as illustrated in Fig.1. Achieving maximum performance requires proper installation, with the modules oriented towards the South in Northern hemisphere and their surface exposed as perpendicularly possible to the incident rays of the sun; furthermore, avoiding any shading caused by obstacles in and around the area of installation.

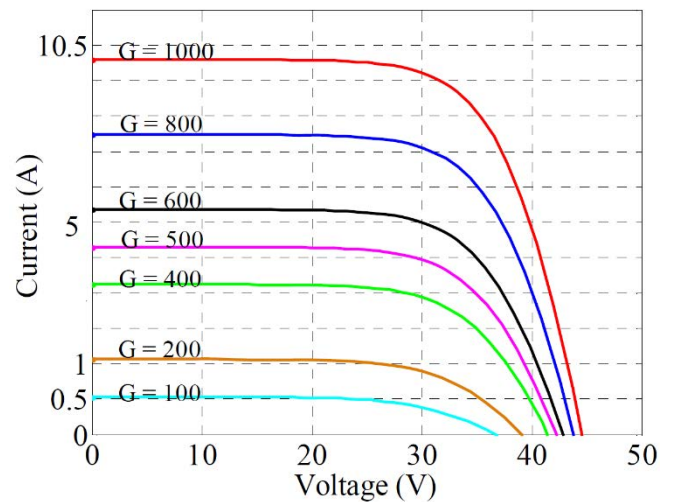

Fig. 1: IV curve at different irradiances

A high ambient temperature and therefore, an increased operational temperature of the modules, also contribute to a proportional reduction in electrical performance. Please see fig. 2

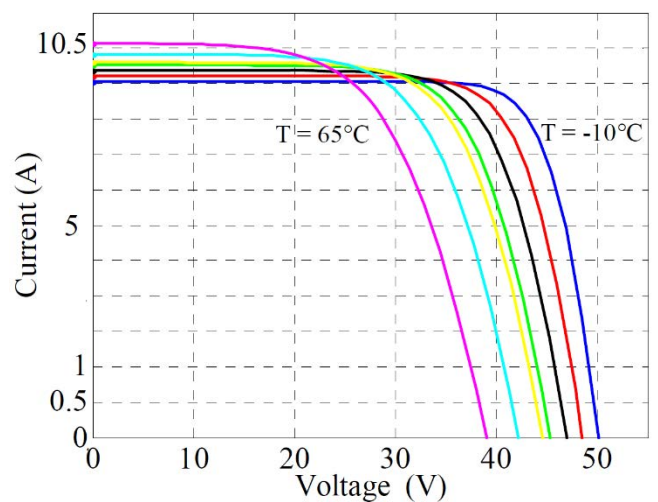

Fig. 2: IV curve at different temperatures

In order to optimize the production of electrical energy of the modules, and therefore of the

system connected to an electrical grid, it is the responsibility of the installer to make sure the modules are positioned as much as possible facing south in northern hemisphere, with the tilt angle (β) (inclination of the surface of the modules in respect to the ground, as shown in Fig.3) optimal for the type of desired application.

The tilt angle of ideal average throughout Italy is $\beta = 30^\circ$; however, even the inclination typical the roof of a dwelling ($\beta = 15-20^\circ$), being already an inclined plane, could make the angle acceptable, if not ideal, for the installation of coplanar modules on it (using a special standard structure for support).

Depending on the variation of the tilt angle of the modules with respect to the ground, or of their orientation in relation to facing south (Azimuth), there will be changes in the annual average amount of energy produced by the modules themselves, and therefore, of the plant connected to the network to which they are linked.

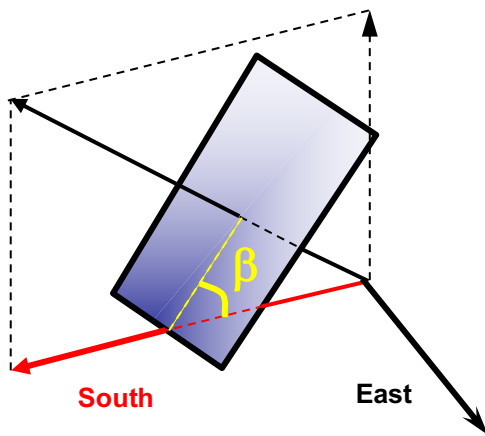

Fig. 3: Orientation Vs. Azimuth

2. Disclaimer of Liability

Since the methods of system design, installation techniques, handling and use of this product are beyond company control; FUTURASUN does not assume responsibility and expressly disclaims liability, for loss, damage or expense resulting from improper installation, handling or use.

3. IEC 61215 & 61730 certifications

This product meets or exceeds the requirements set forth by IEC 61215:2016 and 61730:2016 for PV Modules. These standards cover flat-plate PV modules and panels intended for installation on buildings or those intended to be freestanding. *This product is not intended for use where artificially concentrated sunlight is applied to the module.*

4. Limited Warranty

Please refer to FUTURASUN General Sales Conditions and Product and Performance Warranty for details of the modules' limited warranty. Failure to comply with this Safety and Installation Manual will invalidate FUTURASUN Warranty for the PV modules as stated in the Product and Performance Warranty.

5. Module Specification

Please refer to the technical datasheet for the module FUTURASUN FU XXX respectively for electrical performance data. These electrical data are measured under Standard Test Conditions (STC) of 1000 W/m^2 irradiance, with Air Mass (AM) of 1.5 spectrum, and a cell temperature of 25°C .

6. Safety Precautions

Installation should be performed only by authorized personnel!

- Module installation must be performed in compliance with the latest IEC code (CEI in Italy).
- Within the modules, there are no user serviceable parts. Do not attempt to repair any part of the modules. Contact your module supplier if maintenance is necessary.
- In order to reduce the risk of electric shock, prior to installing the modules, remove metallic jewelry and use insulated tools during installation.
- Do not expose the modules to artificially concentrated sunlight!
- Do not stand on, drop, scratch, or allow objects to fall on the modules.
- Do not lift the modules at the connectors or junction box!
- Do not install or handle the modules when they are wet or during periods of high winds.

- Do not use oil-based lubricants on any part of the junction box as this can cause long-term damage to the plastics.
- Ensure that wire cable connections are routed in accordance with the junction box manufacturer's recommendations. Incorrect routing of the wire cable can lead to stress damage to the junction box.
- The minimum cable diameter for the modules intended for field wiring is 4 mm²
- Please use the connectors following your national regulation: i.e. in some countries it is required to use always the same connector in the entire system Please contact Futurasun to know the exact connector type used in the module you have purchased.
- FuturaSun modules use various connector suppliers for both for 1000 and 1500 V module variants. Please ensure with your local FuturaSun representative the correct voltage rating of the connectors for your system.
- The rated voltage of the connector should be 1500 V and the rated current ≥ 30 A.
- The cross section for the connector is 1 x 4,0 mm².
- Do not leave cable connectors exposed in adverse climatic conditions. Water and dust deposits inside the cable connectors can cause long-term damage.
- Broken module glass, a torn back sheet, a broken junction box or broken connectors are electrical safety hazards; consequently, contact with a damaged module can cause electric shock.
- Fire ratings: Spread of Flame and Burning brand Fire Class C (acc. to UL 61730/UL790). Ignitability Test Class E (acc. to IEC 61730-2).
- The total voltage of modules connected in series corresponds to the sum of the voltages of the single modules; whereas connecting the modules in parallel results in adding up the currents. Consequently, strings of inter-connected modules can produce high voltages and high currents and constitute an increased risk of electric shock and may cause injury or death.
- Modules shall not be connected in series to create strings with a higher voltage than the maximum system design voltage and/or the maximum range allowed by the inverter and/or the safe operational

voltage range of safety devices /switchgears composing the system, in the environmental conditions the system will be installed.

- For installation, maintenance, or before making any electrical connection or disconnection, **ensure all modules in the PV array are exposed to a light intensity that is less than 400 W/m²!!** If necessary, the modules should be covered with an opaque cloth or other material in order to shield them from exposure to light intensity greater than 400 W/m².

7. Installation

7a) Module Mounting

- The FU modules are qualified for an operative temperature within the range of -40 to +85 °C.
- The FU modules can be installed at a maximum operating altitude of ≤ 2000 meters.
- When installing FU modules, local building code requirements and regulations must be observed at all times. Sufficient ventilation of the module backside is required and the mounting configuration (e.g. sufficient clearance) should be adapted accordingly.
- ***Do not drill any additional holes into the module frames and do not cover the drainage holes.***
- ***Pre-assembled mounting systems must be confirmed by FUTURASUN in writing in advance***
- The modules can be mounted in every angle from horizontal to vertical, avoiding configurations with the junction box upside down at all times (e.g. trackers with "sleep mode").
- In order to maximize module exposure to direct sunlight, the modules should be oriented to the south in the northern hemisphere and to the north in the southern hemisphere.

Mounting Methods:

Mounting using mounting holes:

- Each module must be securely fastened at a minimum of 4 points.
- Use the 4 mounting holes (slots, see Fig. 4 and 10) on the PV module frame to bolt the module with stainless steel

screws and nuts to the mounting framework.

- The distance of the mounting holes has been designed in order to result in a uniform wind and snow load without damaging the module.
- Do not drill additional holes in the module frame; doing so will void the warranty.

Mounting using clamping method:

- FUTURASUN recommends the use of clamps.
- When using clamps, it is possible to mount the modules in horizontal (the shorter side of one module facing the shorter side of the neighboring module) or in vertical (the longer sides facing each other) configuration. It is recommended to always use stainless steel screws and bolts.
- The modules can be mounted on continuous base structures (inclined or horizontal) such as rails or similar.
- Both base structures must be mounted at the same distance from the symmetrical axis (vertical or horizontal) of the module.
- In vertical configuration, it is strongly recommended to place the supporting elements nearby the mounting holes, or in any case, the distances shown in Fig. 4 should be respected. This is necessary in order to maintain a correct load distribution.
- The FU XXX modules with 60 and 54 cells (or 120 half-cut cells) are qualified to 3600 Pascal (5400 including a safety factor of 1.5) in wind and snow load when the module is fixed in the green area (See Fig. 4, 10)
- The FU XXX modules of size 72 cells (or 144 half-cells) are qualified to 2400 Pascal (3600 including a safety factor of 1.5) in wind and snow load when the module is fixed in the yellow area (See Fig. 4, 10)
- In accordance with Eurocodes - EN 1991, in the 3,4,5 area of the Alpine Region, if fixing are in the yellow areas (See Fig. 4, 10) the load capacity of module could be too low compared to what is necessary. The shape coefficient, the modules tilt and the installation layout must be taken into

account. An accurate check must always be carried out by qualified technician.

- In **horizontal configuration**, fixing the modules by clamping in the green area in fig. 4 is certified to retain the characteristics regarding the static loads
- When clamping the modules in **horizontal configuration** on a support structure, the distances in Fig. 4 have to be applied in order to maintain the resistance against static loads as certified:
- The modules can also be fixed by placing them with their frame on a structure that is supporting the two sides of the frame over their whole length. Also in this case, the position of the mounting clamps must be in accordance with distances indicated in Fig. 4.
- At **least 20 mm spacing** must be maintain between modules

<p>ATTENTION: in the case of installation with modules in the vertical position, it is preferable to maintain the Junction Box located in the upper part of the module. This practice will help reduce, as much as possible, contact between any standing water and the Junction Box, and avoid possible water infiltration.</p>

Fig. 4: Positions for clamping and fixing (full cell module)

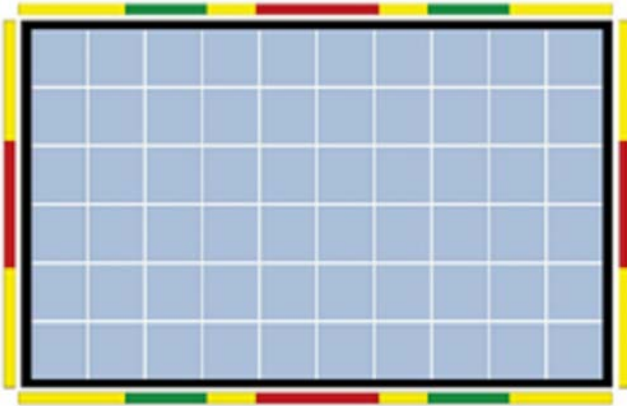

Legend:

- For 60/54 cells (or 120 half-cut cells) module the green areas allow for a certified load upward and downward of 3600 Pa
- For 60/54 cells (or 120 half-cut cells) module the yellow areas allow for a certified load upward and downward of 2400 Pa
- For 72 cells (or 144 half-cut cells) module the green areas allow for a certified load upward and downward of 2400 Pa
- For 72 cells (or 144 half-cut cells) module the yellow allow for a certified load upward and downward of 1600 Pa
- The red areas are not allowed for clamping

Fig. 5: Mechanical drawing of the FU XXX P (54 cells) module showing the mounting holes, the drainage holes, and the ground connection holes.

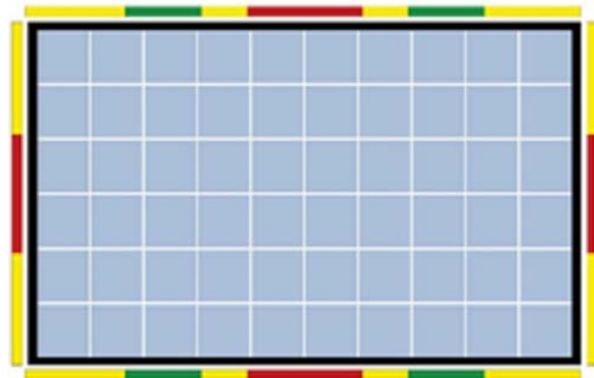
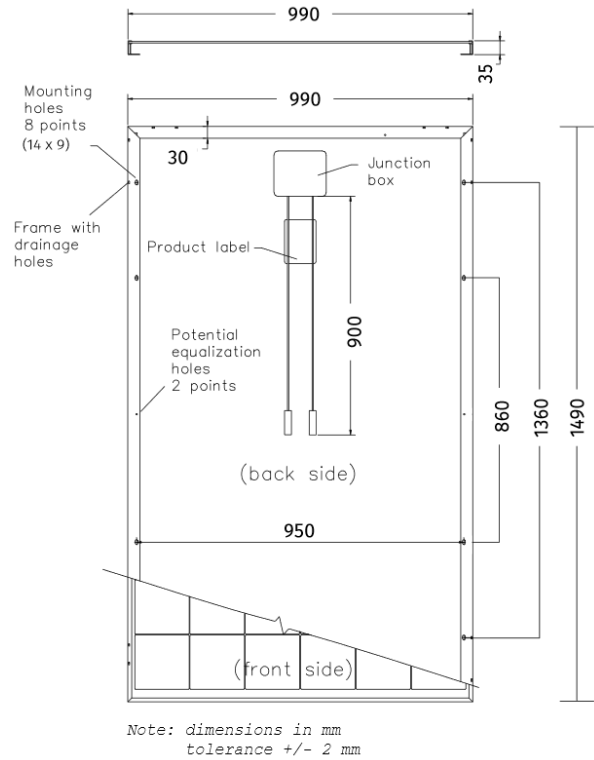

Table 1: Distances for FU XXX P (54 cells) from edge for clamping and fixing (mm)

FU XXX P 54 cells		
Color	min	max
Green ¹	273	473
Yellow ¹	0	596
Red ¹	596	894
Yellow ²	0	149
Red ²	149	842
¹ on long side of frame ² on short side of frame		
tolerance 2 mm		

Fig. 6: Mechanical drawing of the FU XXX P / M / PV / MV (60 cells) module showing the mounting holes, the drainage holes, and the ground connection holes.

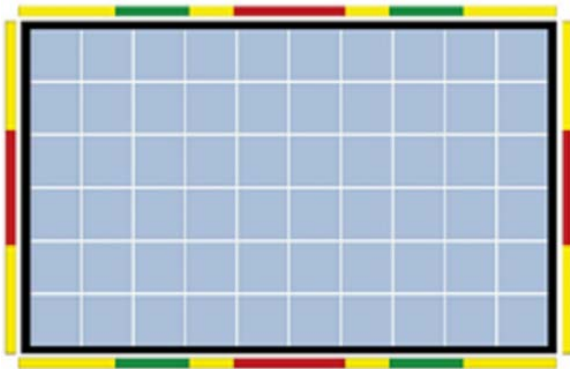
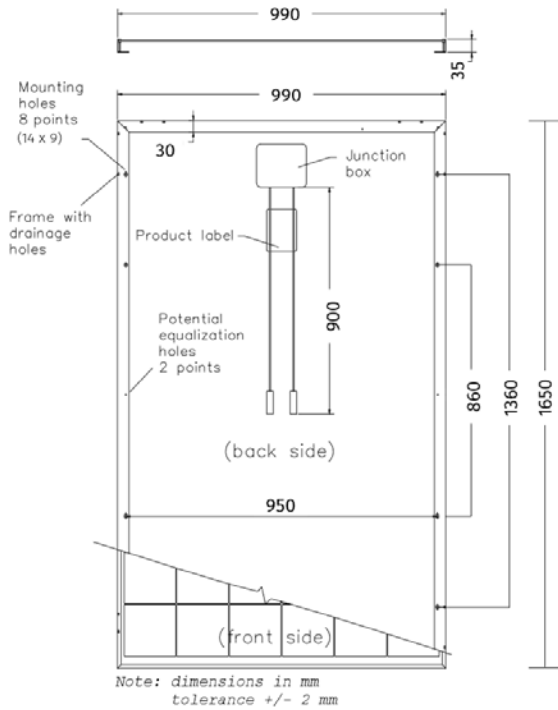

Table 2: Distances for FU XXX P / M / MV / PV (60 cells) from edge for clamping and fixing (mm)

FU XXX P / M / MV / PV (60 cells)		
Color	min	max
Green ¹	313	513
Yellow ¹	0	660
Red ¹	660	990
Yellow ²	0	149
Red ²	149	842
¹ on long side of frame ² on short side of frame		
tolerance 2 mm		

Fig. 7: Mechanical drawing of the FU XXX P / M / PV / MV (72 cells) module showing the mounting holes, the drainage holes, and the ground connection holes.

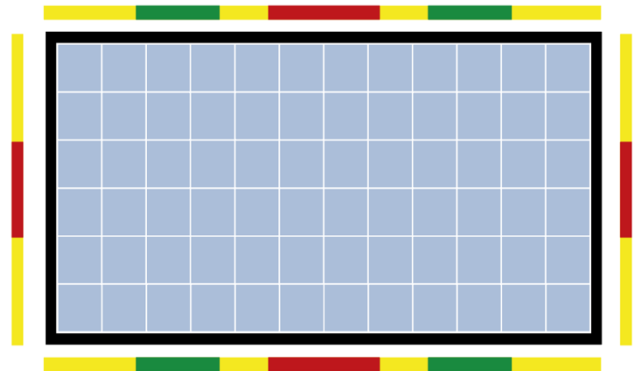
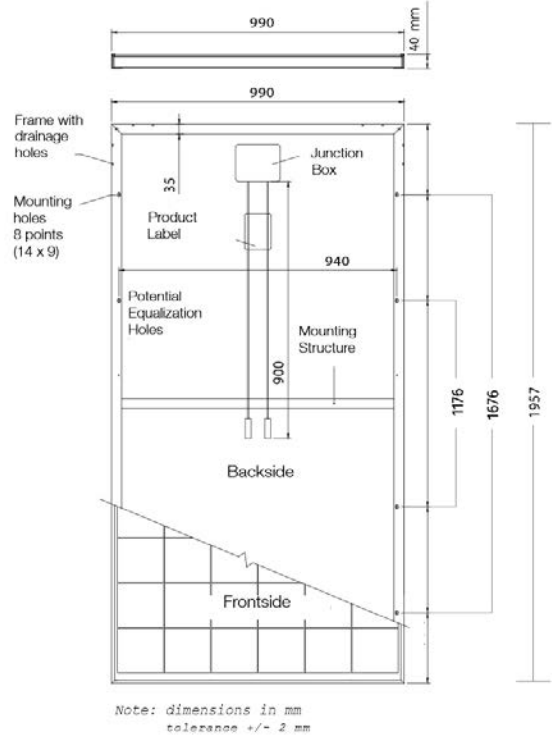

Table 3: Distances for FU XXX P / M / MV / PV (72 cells) from edge for clamping and fixing (mm)

FU XXX P / M / MV / PV (72 cells)		
Color	min	max
Green ¹	389	589
Yellow ¹	0	783
Red ¹	783	1174
Yellow ²	0	149
Red ²	149	842
¹ on long side of frame ² on short side of frame		

tolerance 2 mm

- Fig. 8:** Mechanical drawing of the FU XXX M / MV NEXT (60 cells) module showing the mounting holes, the drainage holes, and the ground connection holes

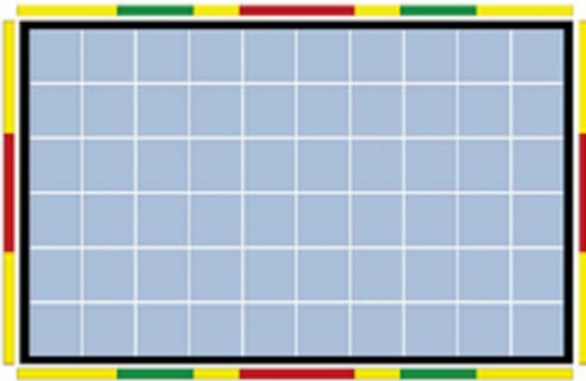
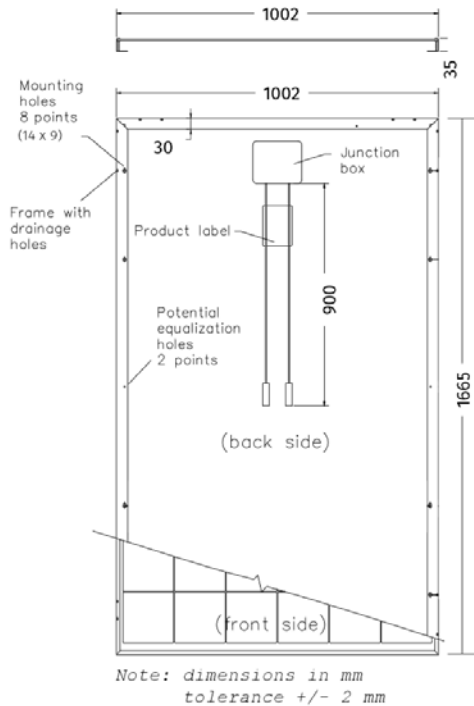

Table 4: Distances for FU XXX M NEXT (60 cells) from edge for clamping and fixing (mm)

FU XXX M / MV NEXT (60 cells)		
Color	min	max
Green ¹	316	516
Yellow ¹	0	666
Red ¹	666	999
Yellow ²	0	150
Red ²	150	852
¹ on long side of frame ² on short side of frame		

tolerance 2 mm

- Fig. 9:** Mechanical drawing of the FU XXX M / MV NEXT (72 cells) module showing the mounting holes, the drainage holes, and the ground connection holes

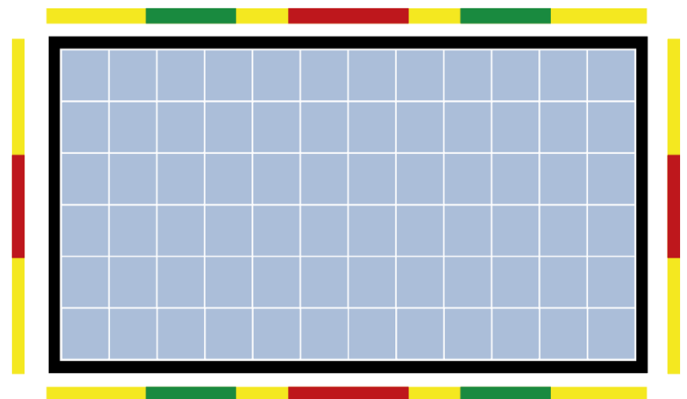
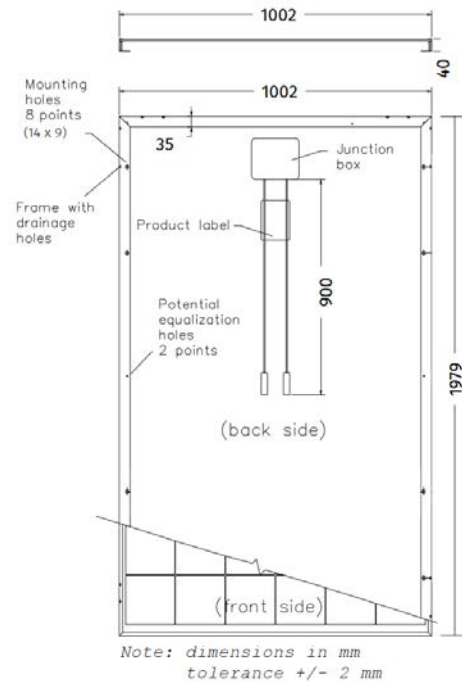

Table 5: Distances for FU XXX M NEXT (72 cells) from edge for clamping and fixing (mm)

FU XXX M / MV NEXT (72 cells)		
Color	min	max
Green ¹	395	595
Yellow ¹	0	792
Red ¹	792	1187
Yellow ²	0	150
Red ²	150	852

¹ on long side of frame | ² on short side of frame

tolerance 2 mm

Fig. 10: Positions for clamping and fixing (half-cut cell module)

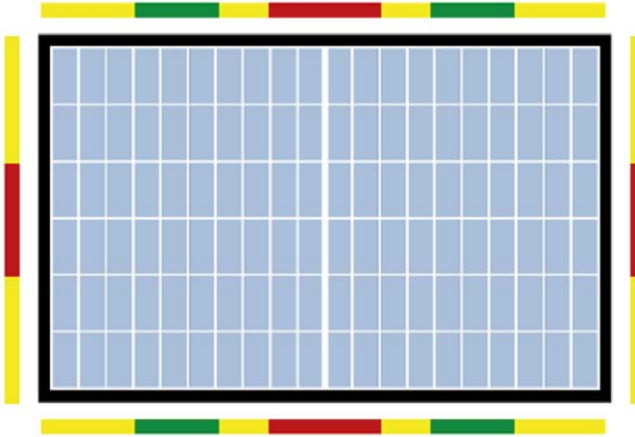

The same legend of **fig. 4** applies

Fig. 11: Mechanical drawing of the FU XXX M / MV NEXT PRO (120 half-cut cells) module showing the mounting holes, the drainage holes, and the ground connection holes

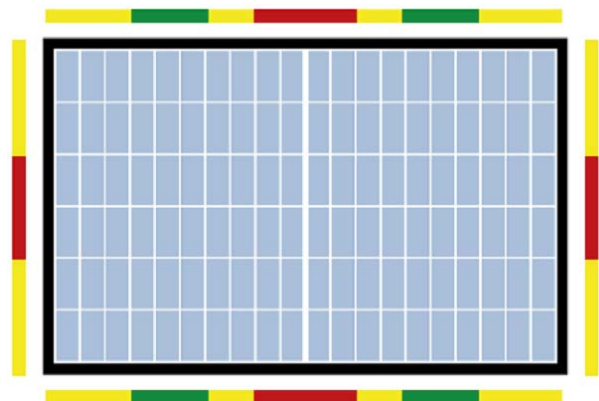
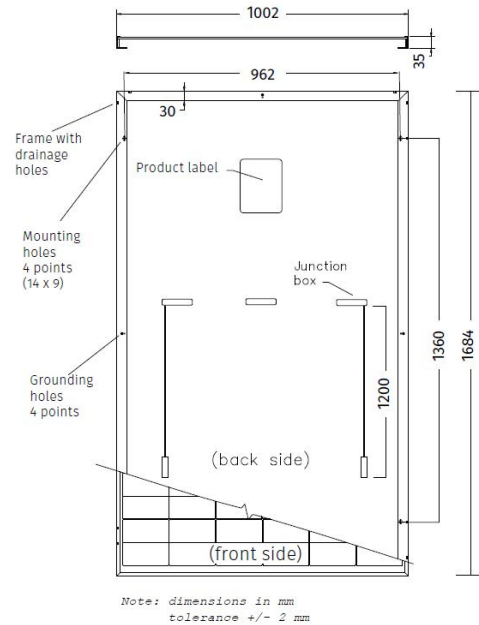

Table 6: Distances for FU XXX M NEXT PRO (120 half-cut cells) from edge for clamping and fixing (mm)

FU XXX M NEXT PRO (120 half-cut cells)		
Color	min	max
Green ¹	321	521
Yellow ¹	0	674
Red ¹	674	1010
Yellow ²	0	150
Red ²	150	852
¹ on long side of frame ² on short side of frame		
tolerance 2 mm		

Fig. 12: Mechanical drawing of the FU XXX M /MV NEXT PRO (144 half-cut cells) module showing the mounting holes, the drainage holes, and the ground connection holes

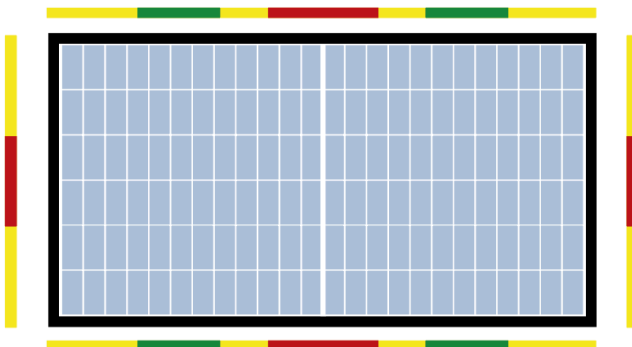
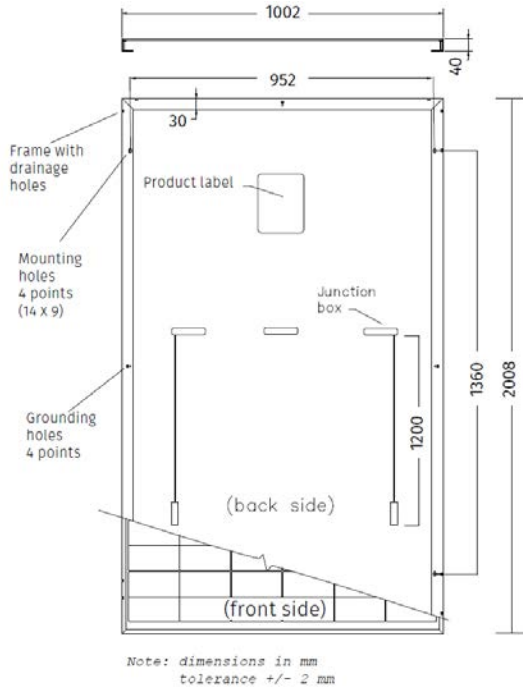

Table 7: Distances for FU XXX M NEXT PRO (144 half-cut cells) from edge for clamping and fixing (mm)

FU XXX M NEXT PRO (144 half-cut cells)		
Color	min	max
Green ¹	402	602
Yellow ¹	0	803
Red ¹	803	1205
Yellow ²	0	150
Red ²	150	852
¹ on long side of frame ² on short side of frame		
tolerance 2 mm		

7b) Module Handling

The FU modules are robust, but in particular, the glass front cover may be subject to damage if improperly handled or installed. Wear **protective gloves** when handling and installing the modules in order to be protected against cutting by sharp edges and against skin burns. Handle the module in a way that avoids breakage or scratching of the front cover glass and mechanical damage to any other part of the module. Do not carry the module by its connector wires in order to avoid the risk of electric shock and prevent damage to the module.

During the wiring and installation of the modules use caution! Do not trample on or scratch the modules. Do not drop sharp or heavy objects on either surfaces of the module. Do not subject the modules to any impact, in particular in the vicinity of the edges of the frames and do not flex them mechanically. The modules are made of a single laminate, therefore once damaged, they are not repairable.

In the event of any damage to either the front or the back of the module, the part exposed might be electrically active and therefore dangerous, especially if the module is connected in series to a string.

7c) Electrical Connection

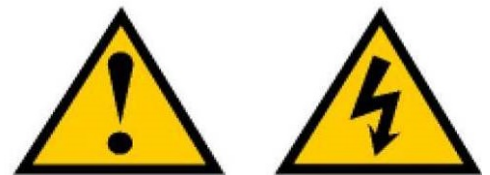

Danger!

Risk of serious injury or death from electric shock or electric arc flash! Do not connect or disconnect modules under load!

Even if the modules are protected against accidental contact, under unfavorable conditions high hazardous voltage (several hundreds of volts) may occur during installation. Consequently, installation and maintenance of the modules, as well as the connection to the main power supply, may only be performed by authorized and qualified persons. *Before connection of the system to*

the grid, the PV system must be approved for correct installation, by an electrician responsible to the operator and the local electricity company.

The design of the PV system should be done by a qualified person familiar with PV system design. The system design is the responsibility of the PV system designer. Therefore, FUTURASUN does not assume any liability for how the modules are installed.

Under normal conditions, a PV module is likely to experience conditions that produce more current and/or voltage than reported at STC. Accordingly, the values of I_{sc} and V_{oc} marked on the module should be multiplied by a factor of 1.25 when determining component voltage ratings, conductor current ratings, fuse sizes, and size of controls connected to the PV output.

The FU modules are qualified in protection class II as for the class of protection against electrical shock in accordance with IEC 61730-1:2016.

Also note:

- **Grounding:** The module frame or array must be grounded before wiring. For grounding, use material that is certified according to CEI 82/25 or applicable national codes – in particular the grounding should be performed by a qualified electrician. *Ensure that the grounding area for the wire is clean and free from oxides or any debris that could impede the electrical grounding.* Attach a separate approved ground wire to one of the holes marked with ground label on the module frame with an IEC approved ring terminal or IEC listed grounding lug.
- V_{oc} should be increased by a factor according to the lowest ambient air temperatures expected for the installation site. Refer to CEI 82/25 (for Italy) or Your local standard for the correct V_{oc} correction factor according to the respective temperatures. If this information is not available, a 1.25 multiplying factor can be used as default value for correction of V_{oc} .
- In order to obtain the required electrical current and/or voltage, the modules can be

connected in series, in parallel, or in a combination of both.

- In the case of series connection, the V_{oc} is the relevant value when calculating the total voltage of the series connection. Do not exceed the maximum system voltage of 1000 V for the modules FU XXX M, P, M NEXT, M NEXT PRO or 1500 V for the modules FU XXX MV, PV, MV NEXT, MV NEXT PRO even at low temperatures. Always use the same type and rating of module in one installation!
 - In the case of parallel connection of modules or series strings of modules, fusing may be required.
 - Fusing of the circuit shall be determined according to the local environmental conditions and regulations. In no case a FU module string in a parallel shall be subject to a total reverse current higher than the I_r value reported in the datasheet
- The voltage of the strings of modules, in series, when measured at their poles, is the sum of all the individual voltages of each module. This total voltage should be compatible with the range of input voltages admissible for the inverter to which the modules are connected.

8. Use and Maintenance

8a) Intended Use

FU modules are designed for use in grid-connected systems. They are therefore linked in series/parallel combinations to feed a dedicated inverter with a DC input and an AC output of 230V/380V AC - 50Hz to provide energy to the local electricity grid.

8b) Operational Measurements

The only two electrical parameters of output from a PV module, measurable with conventional instrumentation, are the V_{oc} and I_{sc} .

When the PV modules are instead connected in series/parallel configuration to an inverter, from its display it is possible to read:

- Operational voltage at maximum power output (V_{mpp}) of the string

- Operational current at maximum power output (I_{mpp}) of the string

From these above values, it is possible to estimate the voltage at maximum power (V_{mpp}) of a module in the string under review and any non-uniformity in the voltages (V_{mpp}) of multiple strings connected to the same inverter.

From the I_{mpp} for the string it is also possible to verify whether there are obvious differences between one string and another. When a uniform condition is detected, it can be assumed that all the modules are working properly.

The following measures serve to collect preliminary information on the operational status of the PV modules in a PV system.

If there is a need to perform direct measurements on individual modules using conventional instrumentation, the following action should be taken.

To measure the open circuit voltage (V_{oc}):

- Note: even in the presence of an insolation average of 500 W/m^2 , a module exposed to the rays of the sun presents at its poles (+ and -) a V_{oc} very close to the nominal value at STC (as shown in Fig.3).
- When taking the temperature at which the module is working at that moment into account, the open circuit voltage module (V_{ocmod}) will be approximately equal to:

$$V_{ocmod} = V_{ocSTC} + [(T_{mod} - 25^{\circ}\text{C}) * \text{Beta}]$$

Where:

- V_{ocSTC} is the open circuit voltage measured at STC;
- Beta is the % variation of V_{oc} of a module per 1°C
- 25°C is the reference temperature of STC;
- In the case of good solar radiation and at the ambient temperature (T_{amb}), one can estimate the temperature of the module as follows:

$$T_{mod} = T_{amb} + 30^{\circ}\text{C}$$

- Using the calculations above, it is possible when measuring with a multi-meter, to verify V_{oc} meets the standard shown in the module datasheet.

- In a case that the V_{oc} to the connectors is decidedly lower than the standard values (75% or less) this could represent a condition of anomaly which should be investigated more thoroughly.

To measure the short-circuit current (I_{sc}):

- A PV module exposed to the south, inclined perpendicularly to the rays of the sun, in the middle of the day (about 12:00 to 1:00 PM) and in conditions of good weather, presents a value of I_{sc} similar to the rated values at STC, as measurable with an amp-meter in continuous current.
- By measuring the solar radiation (E) effective at the moment with a solarmeter/pyranometer in W/m^2 the short circuit current of the module at the moment I_{scmod} should be very close to the following value:

$$I_{scmod} = I_{scSTC} \times E/1000$$

Where:

- I_{scSTC} is the short circuit current measured at STC;
- 1000 W/m^2 is the radiation at STC.

- The measurement of the I_{sc} is executable with precision only when using a solarmeter/pyranometer which gives exact information on the conditions of solar radiation at the moment, otherwise it is not reliable.
- In the case of the unavailability of a solarmeter/pyranometer, it will only be possible to have an estimate of the functionality of the module by comparing the value of I_{scmod} measured in relation to those of the other modules of the PV system, measured under the same conditions of irradiation. The acknowledgment of any obvious discrepancies of I_{sc} in the modules thus serves to identify anomalies.

- The maximum module configuration when connected in series is 25 modules size 54 cells for 1000 V DC systems**
- The maximum module configuration when connected in series is 20 modules size 60 cells (or 120 half-cut cells) and 17 modules size 72 cells (or 144 half-cut cells) of the model FU XXX for 1000 V DC systems**

- **The maximum module configuration when connected in series is 31 modules size 60 cell (or 120 half-cut cells) and 26 modules size 72 cells (or 144 half-cut cells) of the model FU XXX for 1500 V DC systems**
- **For parallel connections, the maximum configuration is 2 strings**

8c) Maintenance

Although PV modules do not require any routine maintenance, periodic (annual) inspection for damage to glass and inspection of the electrical connections and for corrosion as well as the mechanical connection is recommended.

Under normal conditions (sufficient rainfall), cleaning of the module is not required. In extreme climatic conditions, the electrical performance of the module may be affected by accumulation of dirt on the glass front cover. In this case, the front cover can be washed using water (no aggressive cleaning solutions, chemicals or abrasives) and a soft cloth.

Exercise extreme caution when applying water on any electrical device!!

ATTENTION

To avoid the phenomena of electric arcing, both the connection and disconnection of the connectors of the modules being tested and the measurements of V_{oc} should be performed with the string of modules in conditions of open circuit.

In addition, the I_{sc} should be measured for each individual module in conditions of short circuit

9. Packaging, Handling and Storage of Modules

9a) FUTURASUN's Packaging

FUTURASUN provides the FU modules in the most appropriate packaging, designed to guarantee that the transportation and storage will be in conditions of maximum safety and protection until the time of installation. **Transport the module in its original**

packaging until installation. Protect all parts of the module during transport and installation from mechanical stresses.

9b) How to Manage the Packaging

Each package has been designed to allow the shipment and storage of modules in order to maintain their integrity unchanged over time, provided that the information and indications supplied by FUTURASUN are closely observed and followed. These indications are summarised by a series of standard symbols posted in a visible manner on each pallet. The list below illustrates the meaning of each symbol (you can find some of them in each pallet):



DO NOT STACK: each pallet of modules is packaged according to the maximum number of modules stackable vertically, in order to avoid or reduce mechanical stress or damage as a result of the pressure exerted by the stacked modules. Therefore, it is absolutely forbidden to stack more than one pallet on top of another, both in the process of shipment and storage of modules.



DO NOT EXPOSE TO ATMOSPHERIC AGENTS: each pallet of modules is suitably dressed in a cap of transparent plastic in order to avoid temporary contact with generic water spray or atmospheric agents. The plastic casing does not ensure the protection of the modules in the case of prolonged exposure to atmospheric agents. Similarly, in the case of flooding, the pallet does not ensure the maintenance of the mechanical properties of the weight of the modules. For this reason it is recommended to store the pallet in a place that is sheltered and dry. In addition, as the the junction box has an IP68 degree of protection, in the event of a flood the stagnant water inside of the frame could oxidise the metal contacts of the connectors degrading the characteristics and altering the electrical properties of the contacts of the module causing damage.



DO NOT OVERTURN THE PACKAGING: the packaging is only designed to be handled and stored with the modules maintaining the position of the

arrow printed on the packaging, with the arrow always facing upwards. Not following these indicated directions may create forms of mechanical stress on the modules that could cause damage or breakage.



RECYCLABLE: most of the photovoltaic modules are recyclable. They should not be thrown into landfill without a proper method for recycling.

After the approval of EU Directive 2012/19/UE the photovoltaic modules are classified as electronic waste.



FRAGILE: the photovoltaic modules are manufactured using a glass front which makes up approximately 70% of the total materials used to construct

them. Although the modules are stiffened by an aluminium frame, any direct impact to the glass or on the corners of the modules should be avoided. Avoid flexing the laminates or applying non distributed loads and stresses. *Avoid scratching the surface of the exterior glass or backsheet.* Do not apply any forces to the backsheets.



HANDLE WITH CARE: during the operation of shipping and storage of the modules use maximum care to ensure the full integrity of the modules.

9c) How to Handle the Pallet

During the handling of the pallet make sure to pay the utmost attention. The packaging must be raised/moved exclusively with fork-lift trucks or hand pallet trucks fitted with forks of length appropriate to its size and weight.

Pay attention during the stages of handling and unpacking. Verify that the package is

positioned on a surface that is either flat or not excessively deformed to a point that would impart an inclination to the pallets which could damage the PV modules.

FUTURASUN DOES NOT ASSUME RESPONSIBILITY IN THE EVENT OF DAMAGE TO THE MODULES ARISING FROM MANAGEMENT OF THE PACKAGING THAT IS IMPROPER OR DIFFERENT FROM WHAT WAS STATED IN THIS DOCUMENT.

9d) Unpacking

Observe the following procedures for the unpacking of modules:

- Place the packaging on a stable and flat surface
- Using a cutter, cut the plastic wrap surrounding the package or to open the paper box
- Remove the plastic wrap
- Remove the upper cover
- Recover the flash list (for record keeping)
- Using a cutter, cut the straps
- Remove the PV modules and their protective corners without damaging

Note: avoid storing partial packaging!
Once you have removed the strapping the packaging must no longer be moved!!